

NOTES:

1. RAMSHIELD® TO BE CONSTRUCTED IN ACCORDANCE WITH SAFE DIRECTION ASSEMBLY DRAWING SD-RB-01022.

| REVISIONS | | | | |
|-----------|------|-------------------------------------|------------|--------|
| REV. | ZONE | DESCRIPTION | DATE | APPV'D |
| A | | Initial Issue, supersedes GR-WB-122 | 25/05/2022 | HW |
| B | | REVISION UPDATED | 18/10/2022 | HW |
| C | | REVISION UPDATED | 26/03/2025 | HW |

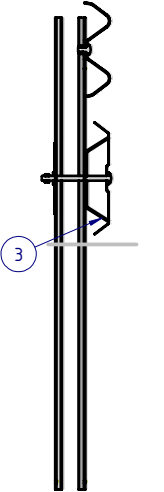
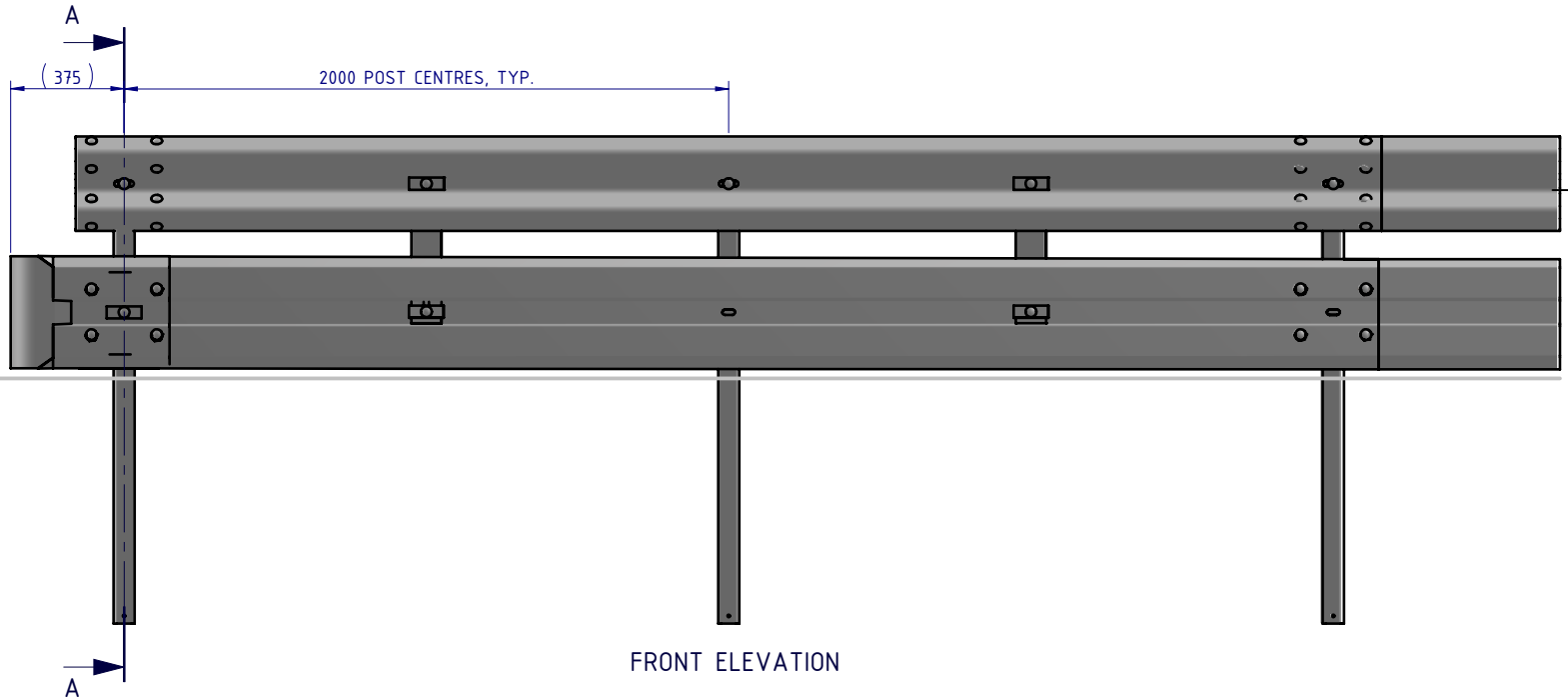
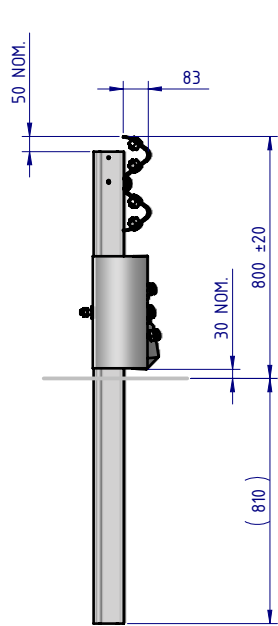
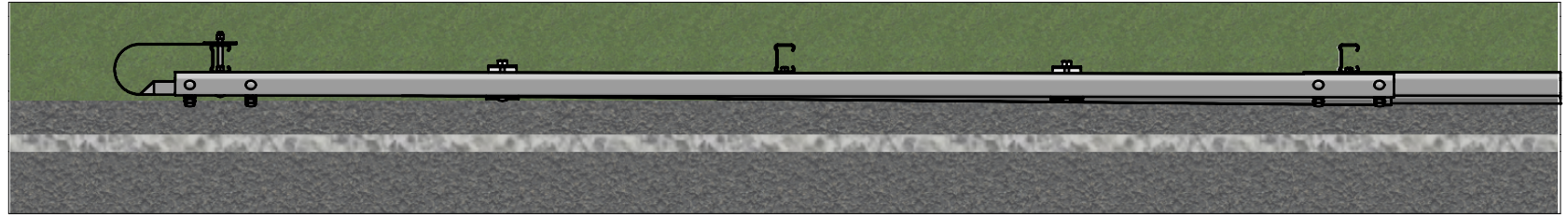
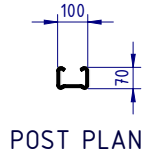

| | | | | | | | | | |
|-----------|--------------|------------|--------------------------------------------------------------------------------------------------------------------------------------------------------------------------------------------------------------------------------------------------------------------------------------------------------------------------------------------------------------------|-------------------------------------------------------------------------------------------------------------------------------|--|-------------------------|----------------------|-------------|--------------|
| MATERIAL: | | | <p>SafeDirection CRASH BARRIER SOLUTIONS</p> | TITLE: Road Barriers - RamShield® W-Beam RamShield® W-Beam, with Biker-Shield™ Bullnose Assembly General Arrangement | | | | | |
| FINISH: | | | | DWG NO. SD-RB-01026 REVISION: C SHEET SIZE: A4 | | | | | |
| STATUS | NAME | DATE | <small>COPYRIGHT: All rights reserved. ABN: 53 156 459 684</small> <small>These drawings, plans and specifications and the copyright therein are the properties of Safe Direction Pty Ltd, and must not be used, reproduced or copied wholly or in part without written permission.</small> <small>U.N.O. TOLERANCES: ±1mm ALL DIMENSIONS ARE IN: mm</small> | | | WEIGHT: 137.9kg | DO NOT SCALE DRAWING | SCALE: 1:25 | SHEET 1 of 3 |
| DRAWN | W. Rogulski | 25/05/2022 | | | | THIRD ANGLE PROJECTION | | | |
| CHK'D | T. Colquhoun | 18/10/2022 | | | | STATUS: APPROVED | | | |
| APPV'D | H. Wallace | 18/10/2022 | | | | | | | |

| ITEM NO. | QTY | PART NUMBER | DESCRIPTION | Weight kg | NOTES |
|----------|-----|------------------|-----------------------------------------------------------|-----------|-------|
| 1 | 1 | SD-RB-01022 | RamShield® W-Beam, 2m Ctrs, 1560 Posts with Biker-Shield™ | 131.5 | (1) |
| 2 | 1 | GE-MP-EF-0150-AG | Biker-Shield™ Bullnose | 4.7 | |
| 3 | 1 | GE-MP-EF-0280-AG | Post Bracket | 1.0 | |
| 4 | 2 | GR-MP-FS-0000-AG | Plate Washer | 0.2 | |
| 5 | 1 | GR-FS-16-0220-MG | M16x220 Mushroom Head POST Bolt & Nut Assy Class 4.6 HDG | 0.4 | |

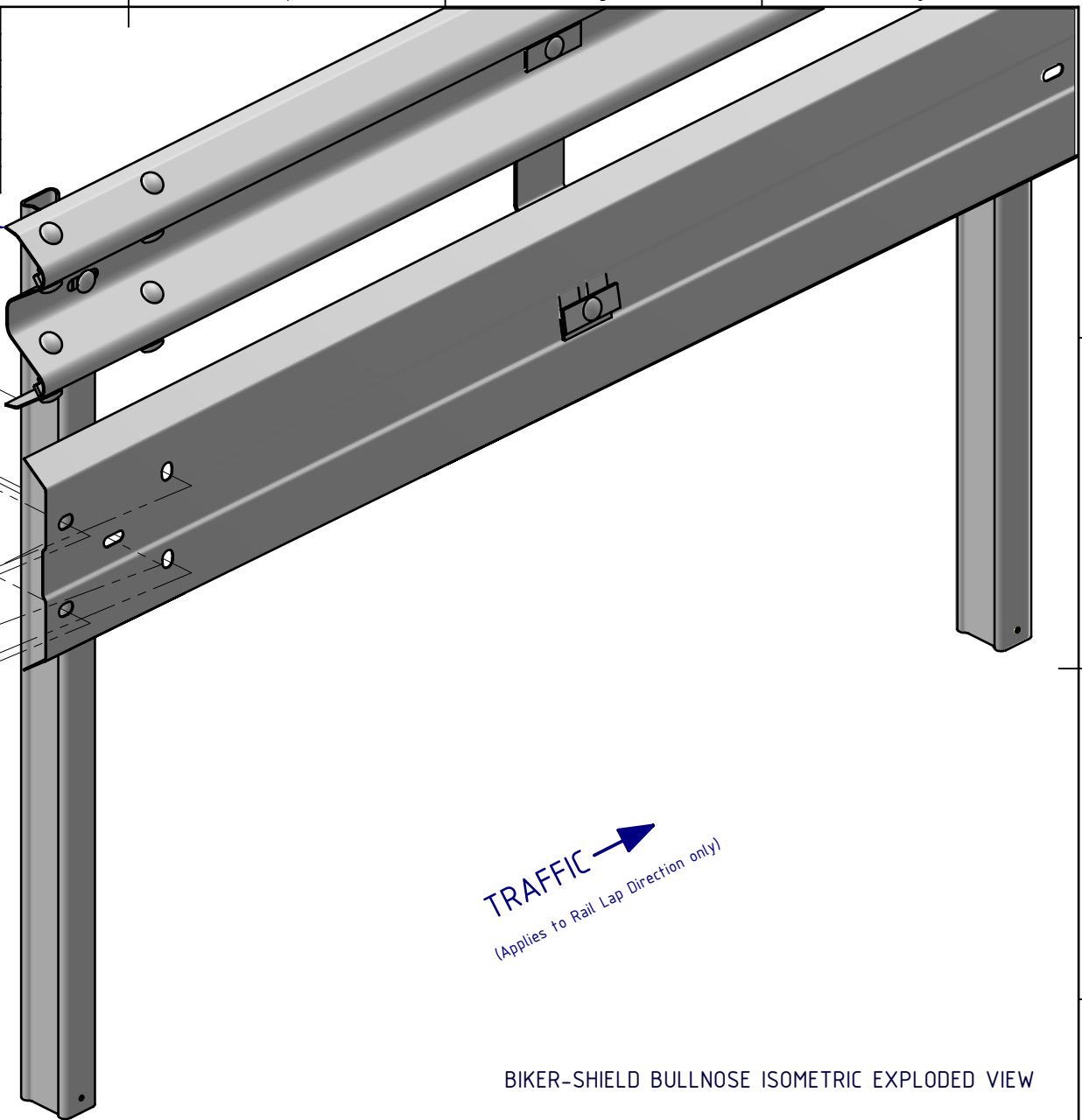

NOTES:
 1. RAMSHIELD® TO BE CONSTRUCTED IN ACCORDANCE WITH SAFE DIRECTION ASSEMBLY DRAWING SD-RB-01022.

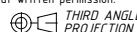
| | | | | | | |
|-----------------|--------------|------------|----------------------------------------------------------------------------------------------------------------------------------------------------------------------------------------------------------------------------------------------------------------------------------------------------------------------------------------------------------------------------------------------------------------------------------------------------------------------------------|-------------------------------------------------------------------------------------------------------------------------------|--------------|--|
| MATERIAL: | | |  SafeDirection CRASH BARRIER SOLUTIONS | TITLE: Road Barriers - RamShield® W-Beam RamShield® W-Beam, with Biker-Shield™ Bullnose Assembly General Arrangement | | |
| FINISH: | | | | DWG NO. SD-RB-01026 REVISION: C SHEET SIZE A4 | | |
| STATUS | NAME | DATE | <small>COPYRIGHT All rights reserved. ABN: 53 156 459 684 These drawings, plans and specifications and the copyright therein are the properties of Safe Direction Pty Ltd, and must not be used, reproduced or copied wholly or in part without written permission. U.N.O. TOLERANCES: ±1mm ALL DIMENSIONS ARE IN: mm</small>  APPROVED | | | |
| DRAWN | W. Rogulski | 25/05/2022 | | | | |
| CHK'D | T. Colquhoun | 18/10/2022 | | | | |
| APPV'D | H. Wallace | 18/10/2022 | | | | |
| WEIGHT: 137.9kg | | | DO NOT SCALE DRAWING | SCALE: 1:10 | SHEET 2 of 3 | |

NOTES:

1. RAMSHIELD® TO BE CONSTRUCTED IN ACCORDANCE WITH SAFE DIRECTION ASSEMBLY DRAWING SD-RB-01022.

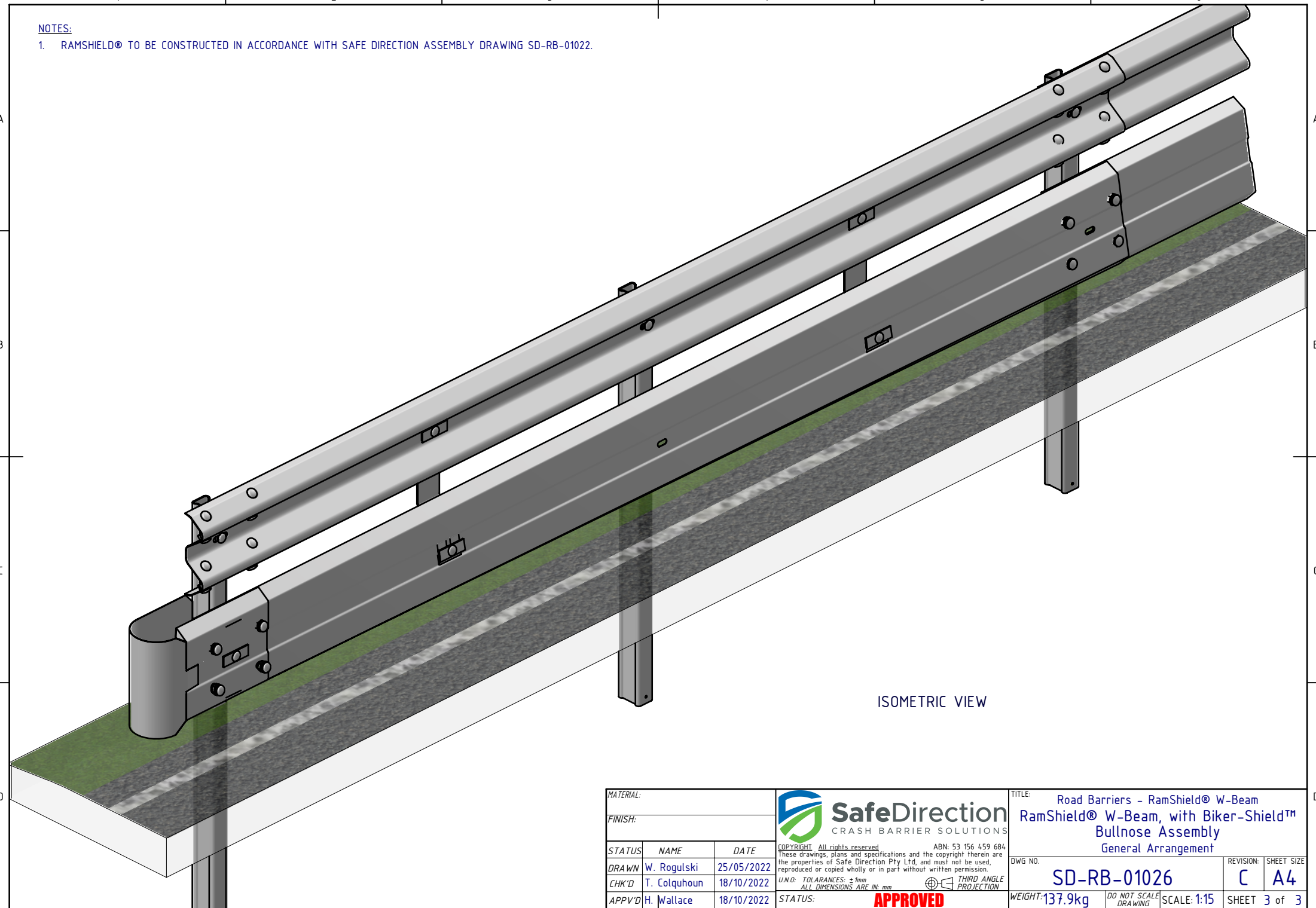

ISOMETRIC VIEW

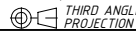
| | | | | | | | | |
|-----------|--------------|------------|---------------------------------------------------------------------------------------------------------------------------------------|-------------------------------------------------------------------------------------------------------------------------------------------------------------------------------------------------------------------------------------------------------------------------------------------|---------------------|----------------------|----------------|--------------|
| MATERIAL: | | |  SafeDirection CRASH BARRIER SOLUTIONS | TITLE: Road Barriers - RamShield® W-Beam RamShield® W-Beam, with Biker-Shield™ Bullnose Assembly General Arrangement | | | | |
| FINISH: | | | | <small>COPYRIGHT: All rights reserved. ABN: 53 156 459 684 These drawings, plans and specifications and the copyright therein are the properties of Safe Direction Pty Ltd, and must not be used, reproduced or copied wholly or in part without written permission.</small> | DWG NO. SD-RB-01026 | REVISION: C | SHEET SIZE: A4 | |
| STATUS | NAME | DATE | <small>U.N.O. TOLERANCES: ±1mm ALL DIMENSIONS ARE IN: mm</small> |  THIRD ANGLE PROJECTION | WEIGHT: 137.9kg | DO NOT SCALE DRAWING | SCALE: 1:15 | SHEET 3 of 3 |
| DRAWN | W. Rogulski | 25/05/2022 | STATUS: APPROVED | <small>C:\Users\wesam.refah\Documents\SDSYD\SDY\Assembly\SD-RB Road Barriers\SD-RB-01000 RamShield W-Beam\SD-RB-01026 - Biker-Shield Bullnose Assembly\ Wednesday, 26 March 2025 4:14:31 PM</small> | | | | |
| CHK'D | T. Colquhoun | 18/10/2022 | | | | | | |
| APPV'D | H. Wallace | 18/10/2022 | | | | | | |